

User manual

Lithium-Ion Storage Battery

Product Model: GTX3000



Contents

1	General Information	1
1.1	Validity	1
1.2	Intended Use	1
1.3	Identifying The Product	3
2	Safety	5
3	Technical Data.....	7
4	Technical Items	11
5	Product Overview.....	13
5.1	Brief Introduction	13
5.2	Battery System Overview	15
5.3	GTX3000-BCU	16
5.3.1	Technical Data	17
5.3.2	LED Indicator Definition	17
5.3.3	Port Definition	19
5.4	GTX3000-H Battery Module.....	24
5.4.1	Technical Data	25
5.4.2	Port Definition	26
6	Installation Guide	27
6.1	Checking Before Installation	27
6.1.1	Checking Outer Packing Materials.....	27
6.1.2	Checking Deliverables	28
6.2	Tools	33
6.3	Installation requirements	33

6.3.1	Installation environment requirements	33
6.3.2	Installation carrier requirements	35
6.4	Installation Instructions	36
6.4.1	Dimensions	36
6.4.2	Installation Step	38
7	Cleaning and Maintenance	53
7.1	Cleaning	53
7.2	Maintenance	53
7.2.1	Recharge Requirements During Normal Storage	53
7.2.2	Recharge Requirements When Over Discharged	54
7.2.3	Replacement or expand capacity	55
8	Common Issues and Solutions	59
8.1	Common Issues and Solutions	59
8.2	Emergency	62
8.3	Disposal of the Battery System	63

1 General Information

This manual introduces AMASS GTX3000 LFP Battery Product from SOFAR.

Please read this manual before you use the battery.

Any confusion, please contact SOFAR immediately for advice and clarification.

1.1 Validity

This user manual is applicable to AMASS GTX3000.

This user manual contains AMASS GTX3000 product information, usage guidance, safety information, installation guide and details on common operating issues and subsequent corrective actions.

1.2 Intended Use

AMASS GTX3000 is an energy storage unit that is designed to be used in residential or commercial on-grid applications with the capability for short-term backup.

Notes regarding intended use:

AMASS GTX3000 is not suitable for supporting life-sustaining medical devices.

This product is intended for use only in accordance with the information provided in the enclosed documentation and with the locally applicable standards and regulations. Any other application may cause personal injury or property damage.

The illustrations in this manual are meant only to help explain system configuration concepts, includes usage guidance, safety precautions, and common operating issues and subsequent corrective actions.

Alterations to the product, e.g. changes or modifications, are only permitted with the express written permission of SOFAR. Unauthorized alterations will void warranty claims. SOFAR shall not be held liable for any damage caused by such changes. Any use of the product other than that described in the Intended Use section does not qualify as appropriate. The enclosed documentation is an integral part of this product. Keep the documentation in a convenient place for future reference and observe all instructions contained therein. The type label (see Section 1.3) must remain attached to the product.

AMASS GTX3000 series products must work with compatible inverters which are listed in the “Compatible Inverter List” section of this manual.





Please contact SOFAR or local after-service providers within 1 week once the user





decides to cease using their SOFAR Battery products.

1.3 Identifying The Product

The type labels were attached on the product, which contain the product identification information. For safe usage, the user must be well-informed of the contents in the type labels.

The type labels include:

		Rechargeable Li-ion Battery	
IFpP/41/150/102/[1P16SJ]M/-10+50/95			
Model:	GTX3000-H		
Ratings:	2500Wh/51.2V/50Ah		
Charge Voltage:	56.16V		
Max. Output Power:	1.5KW		
----- AMASSSTORE -----			
Shenzhen SOFAR SOLAR Co., Ltd.			
401, Building 4, AnTongDa Industrial Park, District 68, XingDong Community, XinAn Street, BaoAn District, Shenzhen, GuangDong, P.R. China			
CAUTION !		 	
<ul style="list-style-type: none"> • Do not disassemble • Do not short-circuit • Do not place in fire or near hot source • Please read user manual carefully 			
IEC 62040-1 IEC 62619 SAAxxxxxx			
UN 38.3			
			

		Battery Control Unit	
Model: GTX3000-BCU			
Nominal Voltage:	180V-750V		
Nominal Current:	25A		
Maximum Current:	30A		
----- AMASSSTORE -----			
Shenzhen SOFAR SOLAR Co., Ltd.			
401, Building 4, AnTongDa Industrial Park, District 68, XingDong Community, XinAn Street, BaoAn District, Shenzhen, GuangDong, P.R. China			
CAUTION !		 	
<ul style="list-style-type: none"> • Do not disassemble • Do not short-circuit • Do not place in fire or near hot source • Please read user manual carefully 			
IEC 62040-1 IEC 62619 SAAxxxxxx			
			

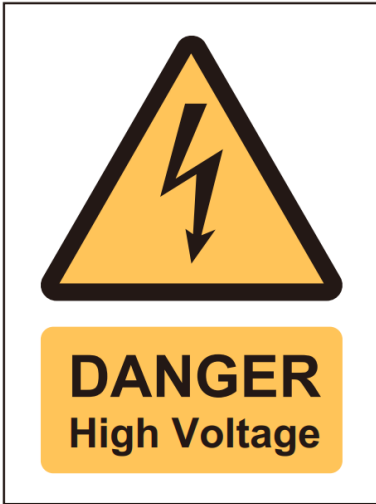

DANGER !
CHEMICAL HAZARD &
SHOCK HAZARD

- Do not disassemble or repair by yourself.
- Do not drop, deform, impact, cut or spear with a sharp object.
- Do not place near open flame or incinerate.
- Do not put any objects onto the battery.
- Do not allow to contact with liquid.
- Keep out of reach of children, animals or insects.
- Contact the supplier within 24 hours if anything wrong.



WARNING !

Stop the battery operation immediately to secure the battery safety when environmental temperature is over working temperature (suitable operation temperature is 0~45°C). If battery is at high temperature usually, it will impact battery performance.

2 Safety

This section contains safety information that must be observed at all times when working on or with batteries. To prevent personal injury or property damage and to ensure long-term operation of the batteries, read this section carefully and observe all safety information at all times.



WARNING

Environmental Requirement

Do not expose the battery to temperature above 50°C

Do not place the battery near any heat sources

Do not expose the battery to moisture or liquids

Do not expose the battery to corrosive gases or liquids

Do not expose the battery to direct sunlight for extended periods of time

Do not allow the battery power terminals to touch conductive objects such as wires

Place battery in secure location away from children and animals

Operation Precautions

Do not disassemble the battery

Do not touch the battery pack with wet hands

Do not crush, drop or puncture the battery

Do not reverse the polarity or connect in series

Do not short circuit the terminals, remove all jewelry items that could product a short circuit before installation and handling

Always dispose of the product according to local safety regulations

Store and recharge battery in a manner in accordance with this user manual

Ensure reliable grounding

Disconnect battery from power/load and then power off battery before installation and maintenance

When storing or handing, do not stack up batteries when outside protective package

Packaged batteries should not be stacked more than specified number stipulated on the package.

Continued operation of a damaged battery can result in dangerous situation that may cause severe injury due to electrical shock.

3 Technical Data

Basic Parameters	GTX3000-H4	GTX3000-H5	GTX3000-H6	GTX3000-H7	GTX3000-H8	GTX3000-H9	GTX3000-H10
Battery module quantity	4	5	6	7	8	9	10
Nominal voltage	204.8V	256V	307.2V	358.4V	409.6V	460.8V	512V
MAX. Charge Voltage	230.4V	288V	345.6V	403.2V	460.8V	518.4V	576V
MIN. Discharge Voltage	182.4V	228V	273.6V	319.2V	364.8V	410.4V	456V
Nominal energy	10kWh	12.5kWh	15kWh	17.5kWh	20kWh	22.5kWh	25kWh
available energy(90% DOD)	9kWh	11.25kWh	13.5kWh	15.75kWh	18kWh	20.25kWh	22.5kWh
Dimension (W*D*H)	515*480 *770 cm	515*480 *895 cm	515*480 *1020 cm	515*480 *1145 cm	515*480 *1270 cm	515*480 *1395 cm	515*480 *1520 cm
Weight(Kg)	138	168	198	228	258	288	318

Protection Class	IP65
Cooling	Natural
Nominal charging current	25A
Max. Continuous charging current	30A
Nominal discharge current	25A
Max. Continuous discharge current	30A
Working Temperature	-20℃ ~ 60℃
Storage Temperature	≤25℃, 12months ≤35℃, 6months ≤45℃, 3months
Environmental humidity	≤ 95%RH (No condensation)
Operating Altitude	≤2000 m
Scale	Suggest no more than 4 parallel

Certificates	UN38.3、IEC62619、IEC62040-1、SAA etc.
Cycle Life	6000 @ 80% DOD / 25°C / 0.5C / 60% EOL

Battery Module Parameters

Battery Type	LiFePO ₄ , Lithium Iron Phosphate
Nominal Voltage	51.2V
Nominal capacity	50AH
Weight(kg)	30kg
Dimension(W*H*D)	515*478.8*125 mm
Protection	IP65

Note:

- 1、Operating current adjust according to cell voltage and battery temperature.
- 2、The parameter will be changed in different string battery module numbers (4~10 pcs battery modules).

4 Technical Items

No.	Terms	Comment
1	Discharge	Battery output power for load
2	Charge	To put electricity into battery by charger
3	Full charge	Battery had been full charged, SOC is 100%.
4	Standby	Ready for charging or discharging
5	Shutdown	Power off
6	SOC	State of Charge(Useable capacity)
7	Battery voltage	The voltage between B+/B-
8	Cell voltage	Single cell voltage
9	Pack voltage	The voltage between P+/P-
10	Alarm	Indicate that the battery is in abnormal status
11	Protect	Battery stops charging or discharging and is recoverable
12	Fault	Battery or BMS is broken, need to be replaced
13	Over discharged	Battery is lack of electricity, and needs to be recharged in time

5 Product Overview

5.1 Brief Introduction

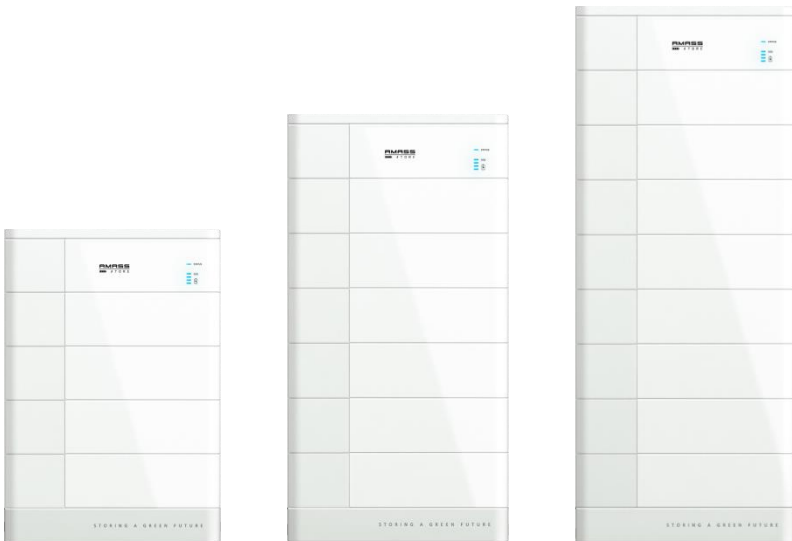

Product overview

The AMASS GTX3000 high-voltage lithium battery energy storage system consisting of 4-10 pcs battery modules (51.2V / 50AH) and one BCU(Battery Control Unit) in series with an operating voltage range between 180V—700V. It is

utilized in household / commercial energy storage applications and works together with a high-voltage inverter to realize the goal of energy storage.

AMASS GTX3000 has built-in BMS (Battery Management System, include master BMS in BCU and slave BMS in battery modules), which can manage and monitor cells information including voltage, current and temperature. What's more, BMS can balance cells charging to extend cycle life. BMS has protection functions including over-discharge, over-charge, over-current and high/low temperature; the system can automatically manage charge state, discharge state and balance state.

AMASS GTX3000 have soft-start circuit, so AMASS GTX3000 can support inverter without soft-start function, and also can support multiple battery system connected in parallel to expand capacity and power for larger capacity and longer power supporting duration requirements. AMASS GTX3000 support up to 8 parallel system operation.

AMASS GTX3000 supports independent charging of each subsystem of the parallel system. When one subsystem is fully charged, the other subsystems will continue to charge until all subsystems are fully charged.

AMASS GTX3000 could support the black start function of compatible inverters.

The ways to trigger this function are different when the battery systems are operated with different inverters.

5.2 Battery System Overview

AMASS GTX3000 series consist of GTX3000-H battery modules and GTX3000-BCU (Battery Control Unit) connected in series.

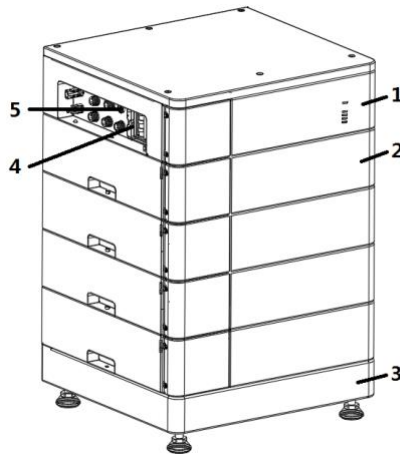

NO.	Description
1	GTX3000-BCU (Battery Control Unit)
2	GTX3000-H (Battery Module)
3	GTX3000-Base
4	Power Switch
5	Start Button

5.3 GTX3000-BCU

BCU include master BMS, Breaker, DC fuse, Soft-start circuit, Charging circuit, Discharge circuit, subsystem charging independent control circuit and 12V DCDC power supply module.

Master BMS control charging voltage/current and discharge voltage/current according to the cell voltage and temperature supply by slave BMS in battery modules through CAN communication to PCS.

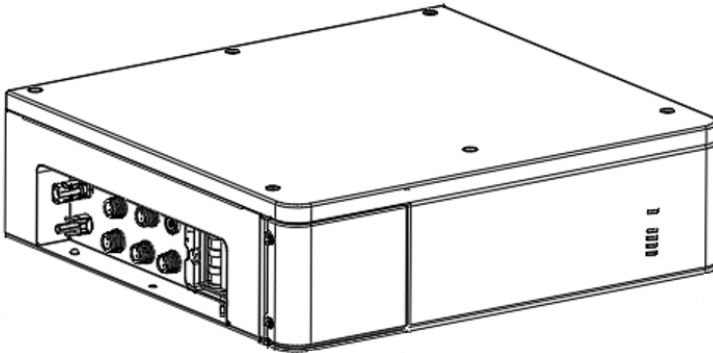

5.3.1 Technical Data

Parameters	Specification
Nominal Voltage	180V—750V
Nominal Current	25A
Maximum Current	30A
Working Temperature	-20℃~60℃
Environmental humidity	≤95%RH
Protection Class	IP65
Cooling	Natural
Weight(kg)	11 kg
Dimension(W*H*D)	515*478.8*144 mm
Communication	CAN / RS485 / RS232
Certificates	IEC62619、IEC62040-1、SAA etc..
Cycle Life	6000 @ 80% DOD / 25℃ / 0.5C

5.3.2 LED Indicator Definition

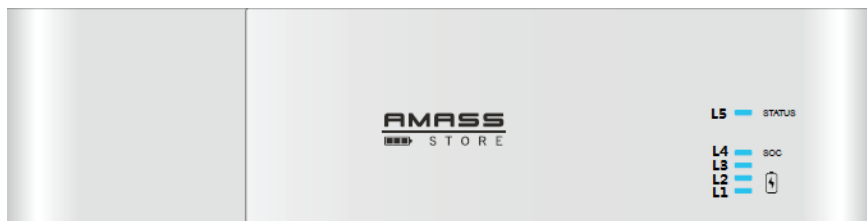







L1 to L4: Blue, show the battery level.





L5: Green, long lighting when charging and flash when discharging.

L5: Red, long bright if equipment failure or protected.

LED Indicators Instructions

Status		L5		L4	L3	L2	L1	Descriptions
								
Shut down		OFF	OFF	OFF	OFF	OFF	OFF	All OFF
Standby		Flash 1	OFF	According to the battery level				Indicates Standby
Charging	Normal	Light	OFF	According to the battery level				The highest capacity indicator LED flashes(flash 2),others lighting
	Full Charged	Light	OFF	Light	Light	Light	Light	Turn to standby status when charger off
	Protection	OFF	Light	OFF	OFF	OFF	OFF	Stop charging
Discharge	Normal	Flash 3	OFF					
	UVP	OFF	OFF	OFF	OFF	OFF	OFF	Stop charging
	Protection	OFF	Light	OFF	OFF	OFF	OFF	Stop discharge
Fault		OFF	Light	OFF	OFF	OFF	OFF	Stop charging and Discharge

Charging Battery Level Indicators Instructions

Status		Charging				
Battery Level Indicator		L5	L4	L3	L2	L1
						
Battery Level (%)	0~25%	Light	OFF	OFF	OFF	Flash 2
	26~50%		OFF	OFF	Flash 2	Light
	51~75%		OFF	Flash 2	Light	Light
	75~100%		Flash 2	Light	Light	Light
	Full Charged		Light	Light	Light	Light

Discharging Battery Level Indicators Instructions

Status		Discharge				
Battery Level Indicator		L5	L4	L3	L2	L1
						
Battery Level (%)	0~25%	Flash 3	OFF	OFF	OFF	Light
	26~50%		OFF	OFF	Light	Light
	51~75%		OFF	Light	Light	Light
	75~100%		Light	Light	Light	Light

Note: The flashing instructions, flash 1 - light 0.25s / off 3.75 seconds; flash 2 - 0.5s light / 0.5s off; flash 3 - 0.5s light / 1.5s off.

5.3.3 Port Definition

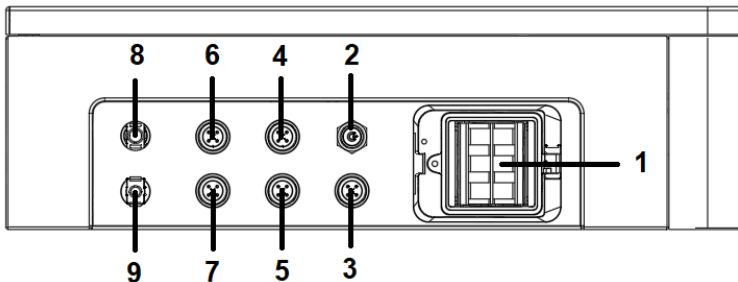

No.	Items	No.	Items
1	Power Switch	6	BCU Link Port In
2	Start Button	7	BCU Link Port Out
3	RS232	8	P-
4	Extend LCD Interface	9	P+
5	Dry Contact Terminal		

5.3.3.1 Power Switch

Main MCB: Power on /off the AMASS GTX3000 battery system.

5.3.3.2 Start Button

1、 Close the Power Switch, press start button more than 3s and then release the button, LED will lights from L5 to L1, and then enters to automatic coding while all LED lights(L5 lights as purple). After finished automatic coding, L1 to L4 shows the normal capacity, and L5 shows the running status:

L5: Green, long lighting when charging and flash when discharging.

L5: Red, long bright if equipment failure or protected.

Note: Before Close Power Switch, must double check all the power cables and communication cables are already installed.

2、 Shut down the battery system: Press start button more than 3s and then release

the button, LED will lights from L1 to L5 to shut down the battery system, and then break the Power Switch.

5.3.3.3 BCU Link Port



PIN	Definition	Note
Pin 1	RS485-B (Blue)	to PCS, reserved
Pin 2	CAN_H (White-Orange)	to PCS
Pin 3	RS485-B (White-Blue)	to PCS, reserved
Pin 4	CAN_L (Orange)	to PCS
Pin 5	GND (Brown)	
Pin 6	ADR_IN- / ADR_OUT- (Green)	Automatic Coding Function
Pin 7	ADR_IN+ / ADR_OUT+ (White-Green)	Automatic Coding Function

BCU Link Port In / Link Port Out communication follow CAN protocol, for communication between batteries and PCS.

- 1、BMS controls the charging current/charging voltage or discharge current/discharge cut-off voltage of the PCS through CAN communication (Master BCU Link Port In) according to the battery voltage and battery temperature.

- 2、 If the battery capacity is less than 8%, BMS controls the PCS to make compulsory recharge through the CAN communication (Master BCU Link Port In) to avoid the damage of the battery due to deep discharge.
- 3、 If SOC was less than 97% for one consecutive month, BMS controlled PCS by CAN communication (Master BCU Link Port In) to full charge the battery to corrected SOC and fully charged capacity.
- 4、 After confirming the wiring is correct(refer to section 6.4.2), long press the startup button of the Master BCU, after normal startup, the parallel BCU will automatically code and assign ID to each parallel BCU, and then the parallel system will run normally.

Note: Through Sofar Solar PCS, customers can set the fully charged time period, which is from 3AM to 6AM by default.

5.3.3.4 RS232 Port

RS232 Communication Terminal (RJ45 port) follows RS232 protocol, for manufacturer or professional engineer to debug or service.

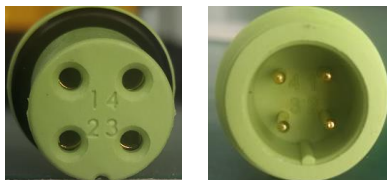

PIN	Definition
Pin 1	RS232_RX
Pin 2	RS232_TX
Pin 3	GND

5.3.3.5 Output Dry Contact Terminal

Dry Contact Terminal: provided 2 output dry contact signal.

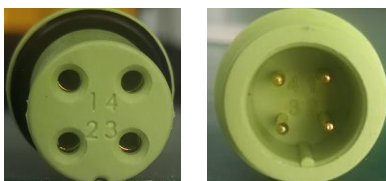

Pin	Definition	Note
1 / 2	Prohibit Discharging	Maximum load capacity : 30V/1A
3 / 4	Prohibit Charging	

5.3.3.6 Extend LCD Terminal

This interface can be connected to an extended LCD to display the detailed operation status of the battery.

Note: External LCD display is an optional accessory.

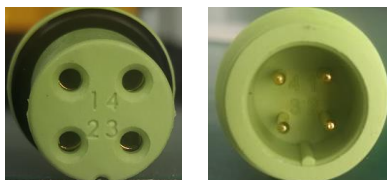

PIN	Definition
Pin 1	SCREEN_B
Pin 2	SCREEN_A
Pin 3	GND_PWR
Pin 4	VCC_LCD

5.4 GTX3000-H Battery Module

Battery module include 51.2V/50AH battery unit and slave BMS. The slave BMS collects the cell voltage and temperature of the battery unit in real time and send these message to the master BMS through internal communication.

Slave BMS integrate cell balance circuit, which can balance cell capacity

according to the control instructions of Master BMS.

5.4.1 Technical Data

Parameters	Specification
Nominal Voltage	51.2V
Nominal Capacity	50Ah
Nominal Energy (100%DOD)	2.5 KWh
Usable Energy (90%DOD)	2.25 KWh
DOD	< 90%
Nominal Charging Current	25A
Maximum Charging Current	30A
Nominal Discharge Current	25A
Maximum Discharge Current	30A
Working Temperature	-20°C~60°C
Environmental humidity	≤95%RH
Protection Class	IP65
Cooling	Natural
Weight(kg)	30 kg
Dimension(W*H*D)	515*478.8*125 mm
Communication	RS485
Certificates	IEC62619、UN38.3、IEC62040-1、SAA etc.
Cycle Life	6000 @ 80% DOD / 25°C / 0.5C

5.4.2 Port Definition

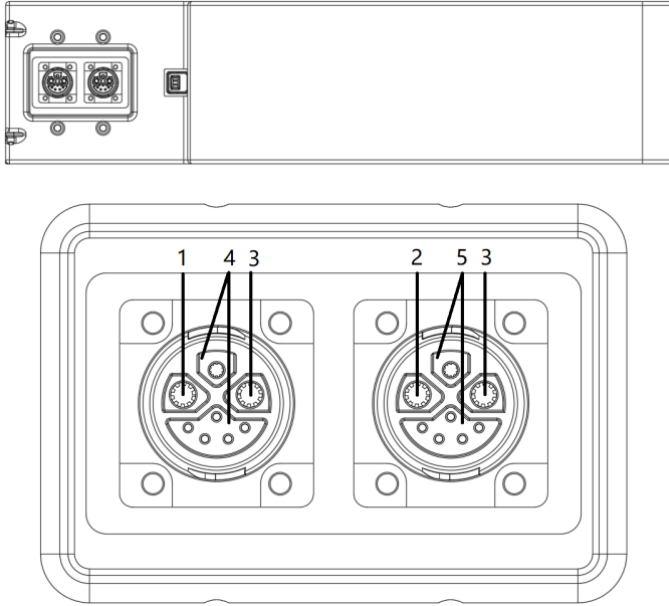

NO.	Items	Description
1	B-	Battery module B-
2	B+	Battery module B+
3	P+	Battery system P+
4	Link Port In	Battery system inner communication signal
5	Link Port Out	Battery system inner communication signal

6 Installation Guide

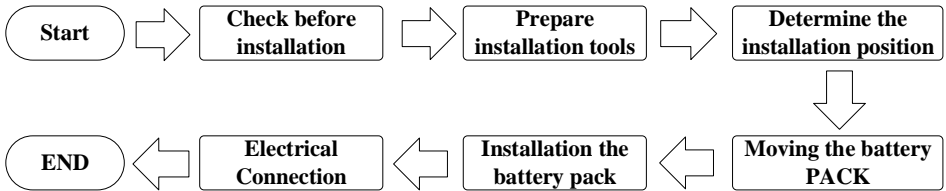

Installation flow chart

6.1 Checking Before Installation

6.1.1 Checking Outer Packing Materials





Packing materials and components may be damaged during transportation. Therefore, check the outer packing materials before installing the battery. Checking the surface of packing material for any damage, such as holes and cracks. If any damage is found, do not unpack the battery and contact the dealer as soon as possible. You are advised to remove the packing materials within 24 hours before installing the battery.



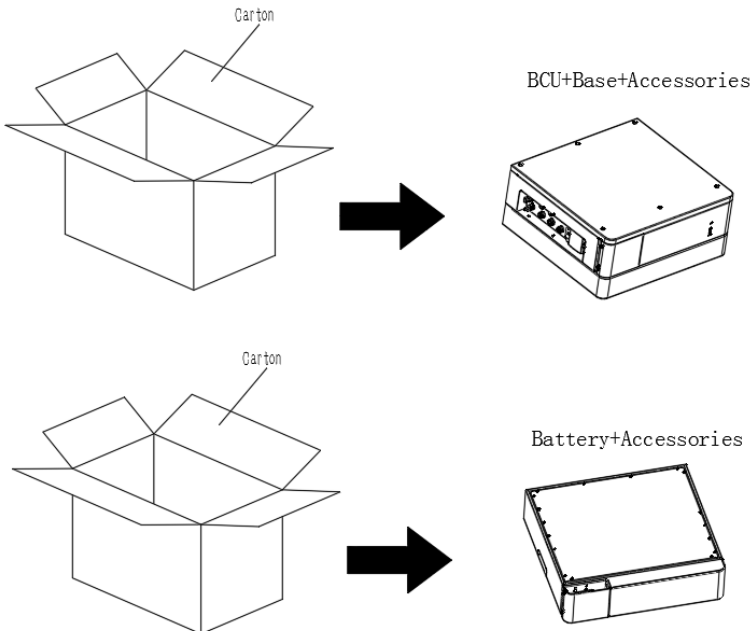

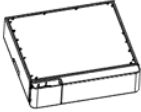
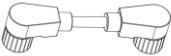
6.1.2 Checking Deliverables





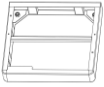
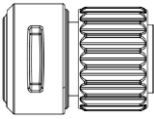

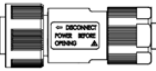
After unpacking the battery, check whether deliverables are intact and complete. If any damage is found or any component is missed, contact the dealer.



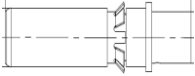
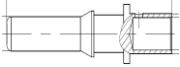

The below table show the components and mechanical parts that should be delivered.



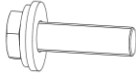









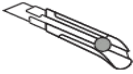

Battery module			
NO.	Pictures	Quantity	Description
1		1PCS	Battery
2		1PCS	wire
3		2PCS	M5
4		1PCS	Test report
5		1PCS	Certificate

BCU and Base			
NO.	Pictures	Quantity	Description
1		1PCS	GTX3000-BCU
2		1PCS	GTX3000-BASE
3		1PCS	P+ connector
4		1PCS	CAN communication cable
5		1PCS	Link port connector (parallel system)
6		1PCS	CAN matching resistor
7		1PCS	4PIN port

8		1PCS	Metal terminals secured to P+ cables
9		1PCS	Metal terminals secured to P- cables
10		1PCS	P+ terminal
11		1PCS	P- terminal
12		4PCS	support leg
13		1PCS	Hanging rack
14		1PCS	Backboard
15		1PCS	M6*12
16		3PCS	M5*12

17		4PCS	M6*60 Expansion bolts
18		4PCS	M5
19		1PCS	Manual
20		1PCS	Test report
21		1PCS	Certificate

6.2 Tools

Model	Tools		
Installation	Knife 	Hammer drill (10mm) 	Socket wrench (10mm) 
	Rubber mallet 	Cross Screwdriver 	Marker 
	Incinometer 	Measuring tape 	
Protection	ESD gloves 	Safety goggles 	Anti-dust respirator 
	Safety shoes 		

6.3 Installation requirements

6.3.1 Installation environment requirements

- Install the battery in the indoor environment.
- Place battery in secure location away from children and animals.
- Do not place the battery near any heat sources and avoid sparks.

- Do not expose the battery to moisture or liquids.
- Do not expose the battery to direct sunlight.

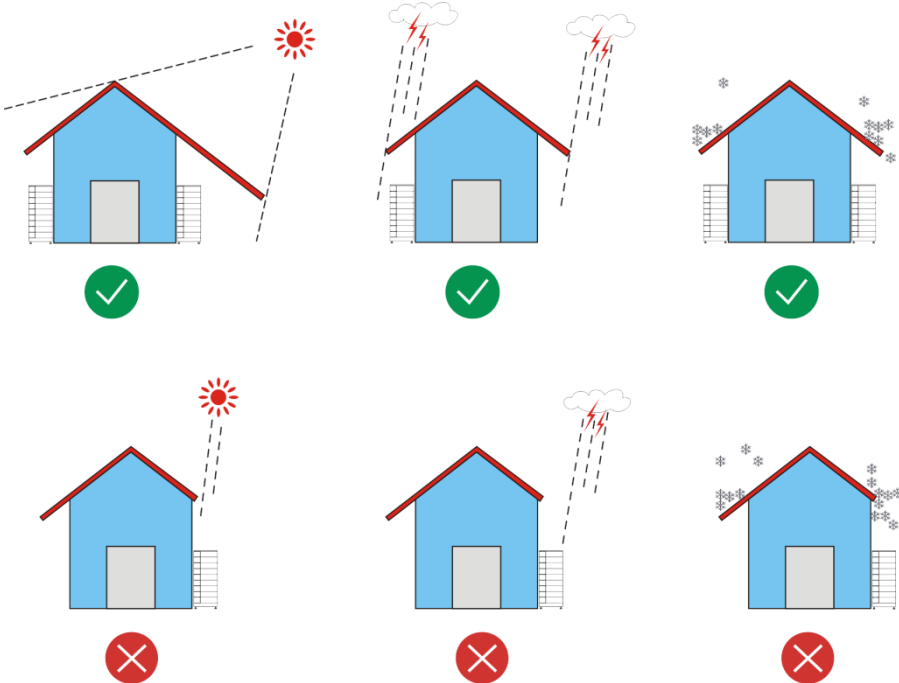

6.3.2 Installation carrier requirements

- The mounting carrier shall have fire resistance. Do not install batteries on flammable buildings.
- The mounting carrier surface shall meet the load bearing requirements.
-



6.4 Installation Instructions

6.4.1 Dimensions

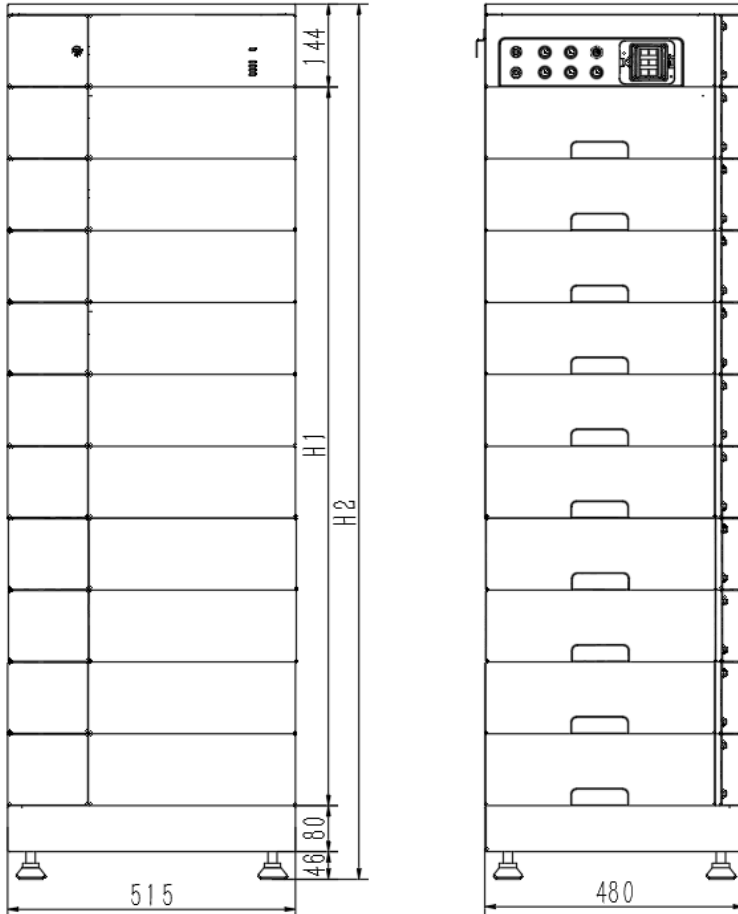

Battery	H1 (mm)	H2 (mm)	Weight (Kg)
4	500	770	160
5	625	895	190
6	750	1020	220
7	875	1145	250
8	1000	1270	280
9	1125	1395	310
10	1250	1520	340

Minimum mounting interval:

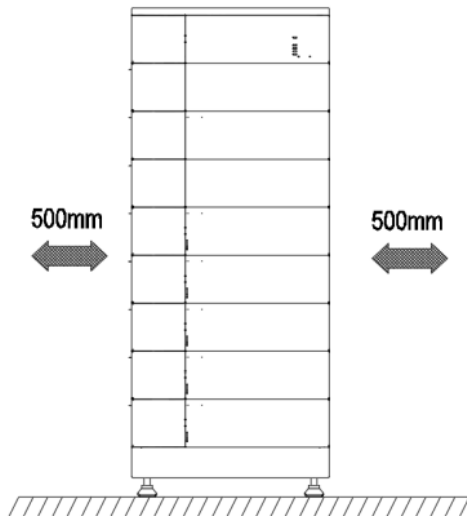

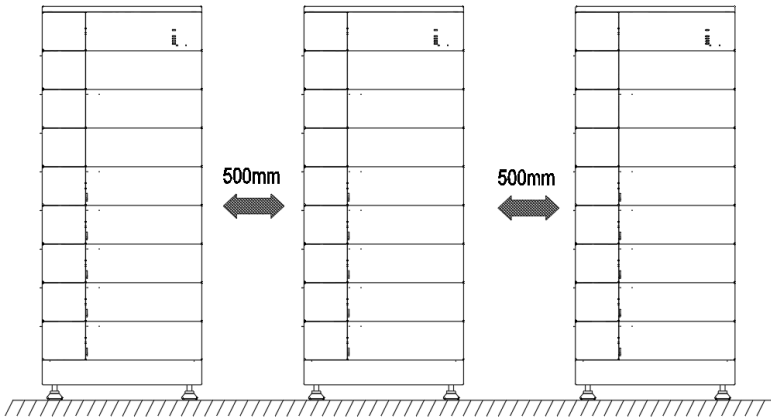

6.4.2 Installation Step

Step 1

Unscrew and separate BCU and base.

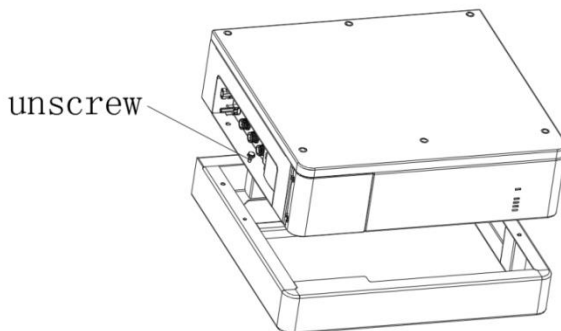

Step 2

Adjust the level of the base with a Level Ruler.

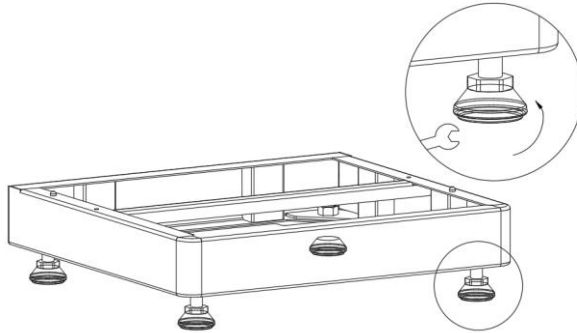
**Step 3**

When the battery module more than 5 (include 5), anti-dumping subassembly shall be installed.

Position the holes according to the number of modules (5-10PCS) and drill the holes with a 10mm drill bit.

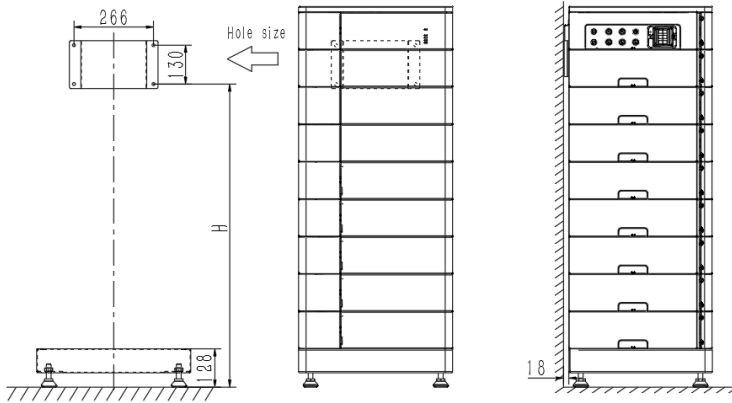

Battery	5	6	7	8	9	10
H (mm)	638	763	888	1013	1138	1263

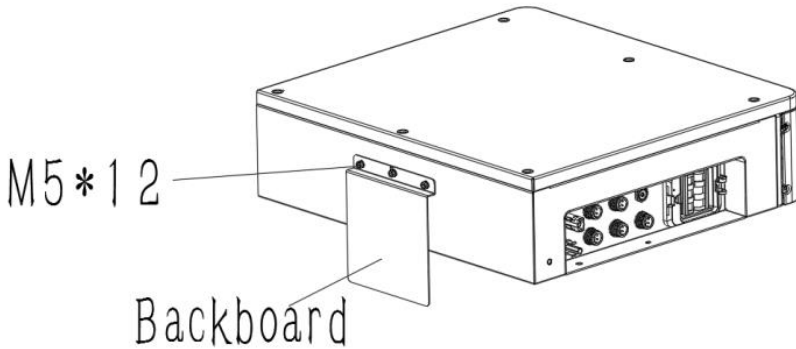

Step 4

Install the batteries.

Tighten the screws to lock the battery module before installing next battery module. Please install the battery modules one by one.

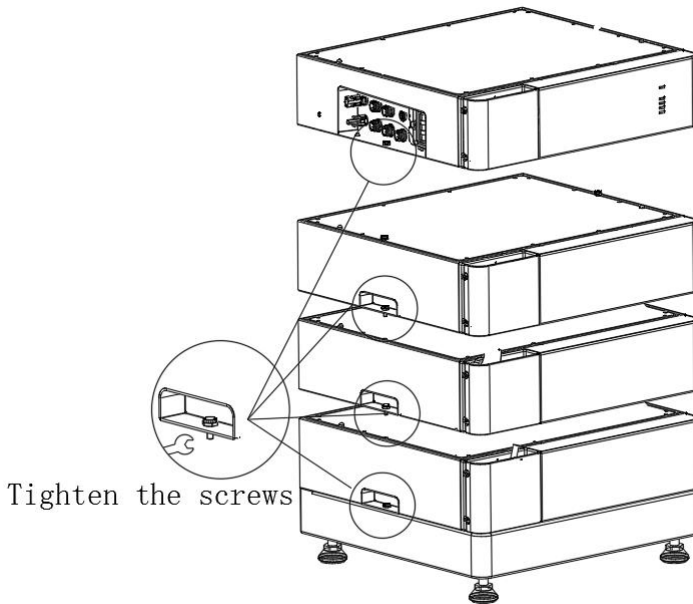

Step 5

Press the middle position of right side of the protective door, open all of the protective doors, ready to wiring.

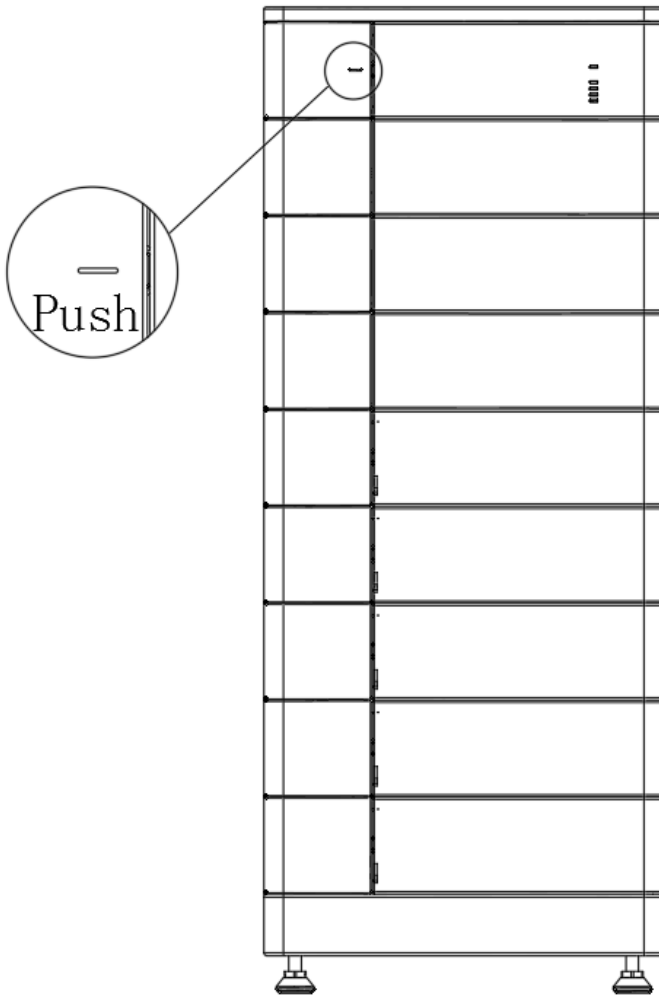

Step 6

Ground connection.

Connect PE line from BCU to ground.

BCU

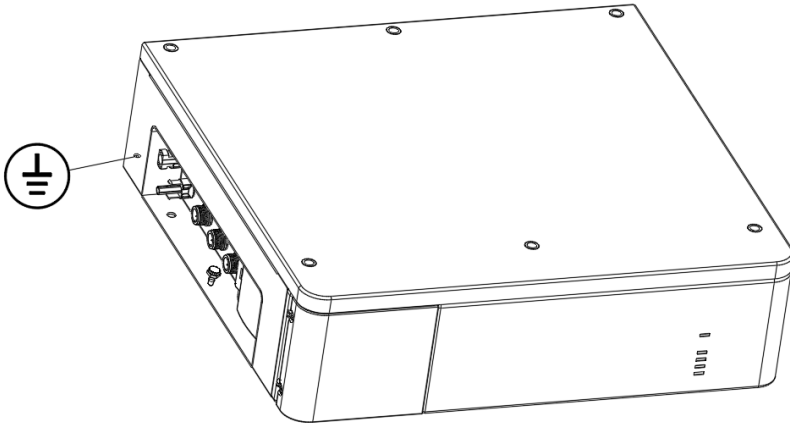

Step 7

Connect the Power wires between the batteries.

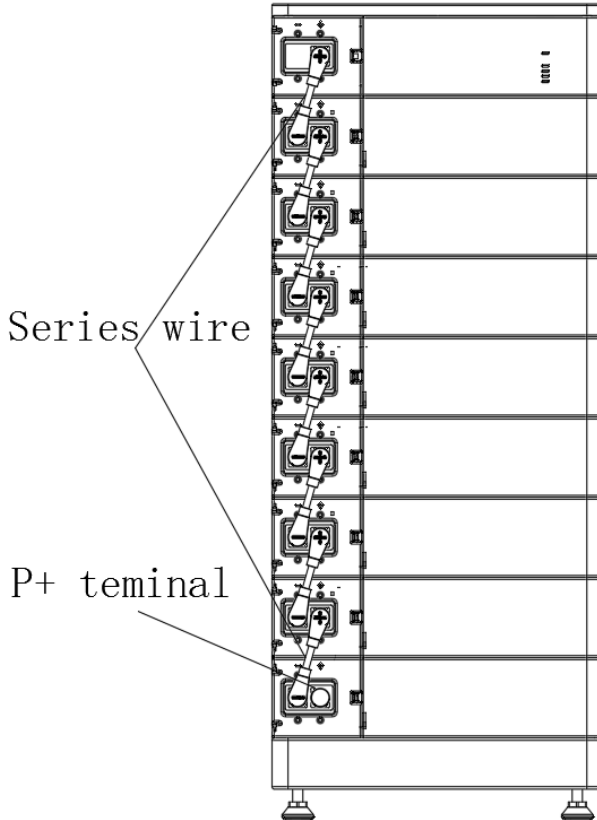

Step 8

Close all of the protective doors.

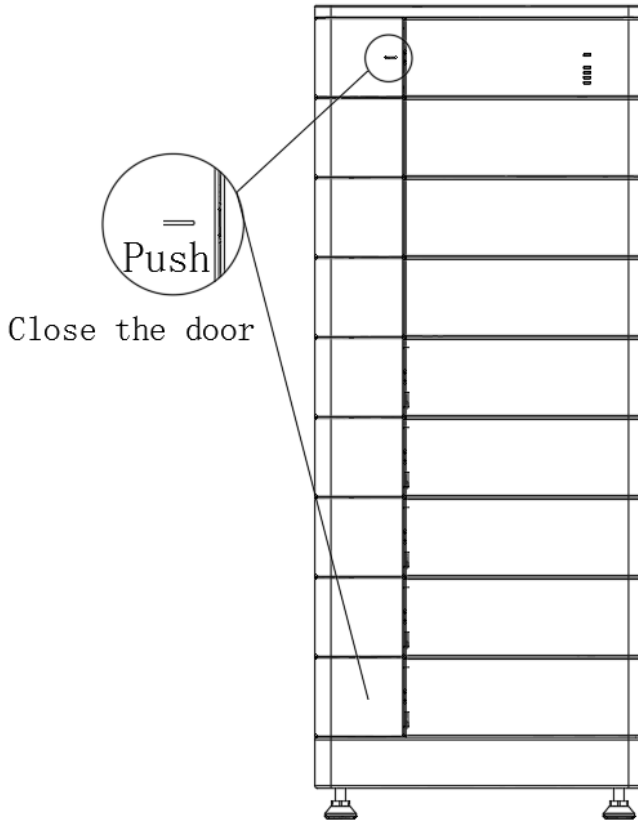



Step 9

Electrical connections.

1、Prepare power cable on side

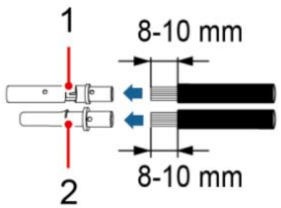
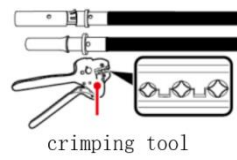
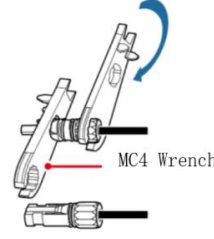
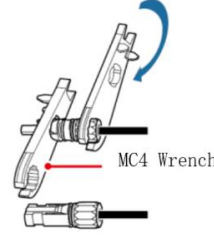
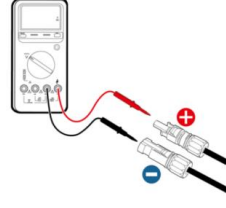
You are advised to use the EV power cable with size 6mm² or 9AWG (1500V, 25A) and length min.1500mm.

 <p>1: Positive metal contact 2: Negative metal contact</p> <p>①</p>	 <p>crimping tool</p> <p>②</p>	 <p>3: Positive connector 4: Negative connector</p> <p>③</p>
 <p>MC4 Wrench</p> <p>④</p>	 <p>⑤</p>	 <p>Connect to BCU</p> <p>⑥</p>
 <p>Disconnect connectors</p> <p>⑦</p>		

2、Prepare CAN communication cable on site

Refer to the following GTX3000-BCU CAN communication cable definition, according to the different inverter communication port definition, made the corresponding communication terminal on site.

GTX3000-BCU CAN communication cable definition:

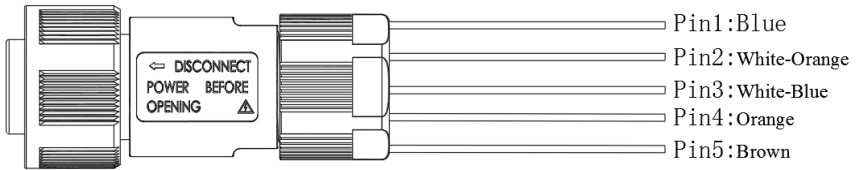

PIN	Color	Definition
Pin 1	Blue	RS485-B
Pin 2	White-Orange	CAN_H
Pin 3	White-Blue	RS485-B
Pin 4	Orange	CAN_L
Pin 5	Brown	GND

3、Single battery system electrical connection

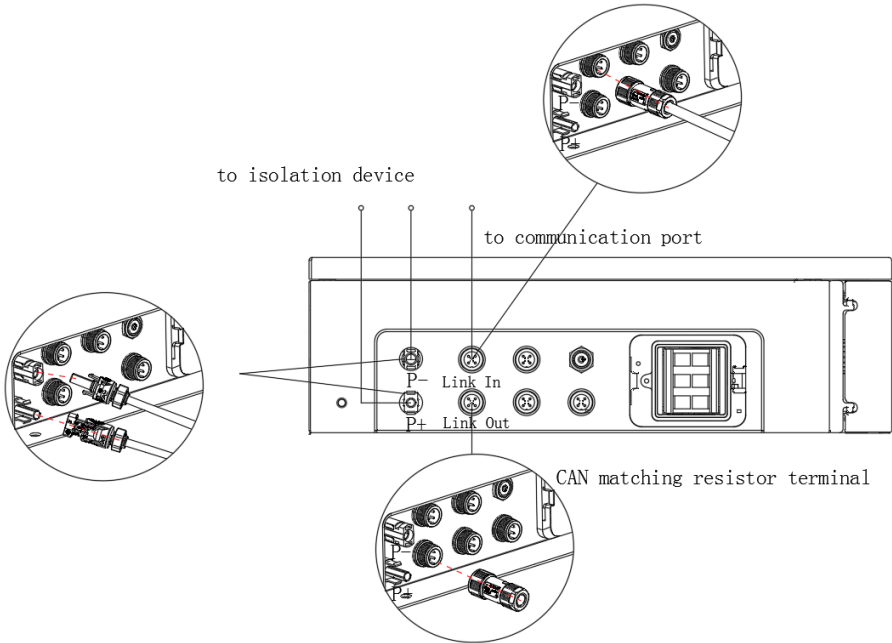

A、Connect Power cable

Connect P+|P- power cable from BCU to isolation device.

Note: Reverse connection prohibited!

B、Connect CAN communication cable

Connect CAN cable from Link In of the BCU to communication port.

C、Connect CAN matching resistor terminal

Connect CAN matching resistor terminal to Link Out of the BCU.

4、 Parallel battery systems electrical connection

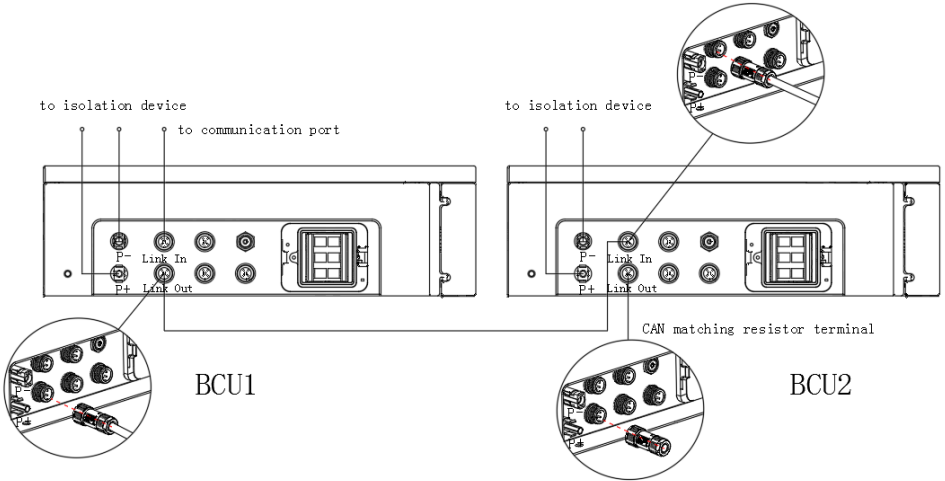

A、 Connect Power cable

Connect P+|P- power cable from BCU to isolation device.

Note: Reverse connection prohibited!

B、 Connect CAN communication cable

Connect CAN cable from Link In of the **BCU1** to communication port.

C、 Connect parallel communication cable

Connect parallel communication cable from Link **Out of the BCU1** to Link **In of the BCU2**.

D、 Connect CAN matching resistor terminal

Connect CAN matching resistor terminal to Link **Out of the BCU2**.

Step 10

Battery system ON/OFF Operation.

Double check all the power cables and communication cables before operation.

1、 Single battery system

- A、 Close power switch of BCU;
- B、 Refer to section 5.3.3.2 to Power ON/OFF the battery system.

2、 Parallel battery system

- A、 Close power switch of BCU1 and BCU2;
- B、 **Press start button of BCU1** more than 3s and then release the button, LED will lights from L5 to L1, and then enters to automatic coding(assign BCU address and battery pack address) while all LED lights(L5 lights as purple). After finished automatic coding, L1 to L4 shows the normal capacity, and L5 shows the running status.

Note:

- 1、 After shut down battery system with start button (Power Switch still close), the

battery system can be activated by charging to start again.

2、The system need to do fully charge for SOC calibration purpose at first power on.

7 Cleaning and Maintenance

7.1 Cleaning

CAUTION:

Please power off the system before cleaning.

It is recommended that the AMASS GTX3000 should be cleaned periodically. If the enclosure is dirty, please use a soft, dry brush or a dust collector to remove the dust. Liquids such as solvents, abrasives or corrosive liquids should not be used to clean the enclosure.

7.2 Maintenance

7.2.1 Recharge Requirements During Normal Storage

Batteries should be stored in an environment with a temperature range between $-10^{\circ}\text{C} \sim +45^{\circ}\text{C}$, and maintained regularly according to the following table with 0.5C (25A) current until 40% SOC after a long time of storage.

Recharge conditions when in storage

Storage Environment Temperature	Relative Humidity of Storage Environment	Storage Time	SOC
Below -10°C	/	prohibit	/
-10~25°C	5%~70%	≤12 months	30% ≤SOC ≤60%
25~35°C	5%~70%	≤6 months	30% ≤SOC ≤60%
35~45°C	5%~70%	≤3 months	30% ≤SOC ≤60%
Above 45°C	/	prohibit	/

7.2.2 Recharge Requirements When Over Discharged

Please recharge the over discharged batteries (**90%DOD**) in a timeframe that is in accordance to the following table, otherwise the over discharged battery modules will be damaged.

Recharge conditions when battery is over discharged

Storage Environment Temperature	Storage Time	Note
-10~25°C	≤15 days	Battery Pack disconnect to PCS
25~45°C	≤7 days	
-10~45°C	< 12 hours	Battery Pack connect to PCS

7.2.3 Replacement or expand capacity

Important:

The installation and all other kinds of works or measurements in combination with the AMASS GTX3000 are only allowed by professional electricians.

Attention:

High Voltage Storage! Improper handling can cause danger and damage.

This section describes how to remove or add battery modules to an existing AMASS GTX3000 system. Please keep in mind the number of modules (4-10 modules).

The SOC level of the new module and the one of the existing battery system need to be on a similar level before expansion.

7.2.3.1 Remove modules

- 1、 Before replacement or expand capacity, please cut off the whole system, include PCS and Battery system; at the same time, PCS is disconnected from the power grid;

- 2、 After PCS is confirmed to be disconnected from the power grid, turn off the battery power supply and disconnect the connection line between the battery and inverter.
- 3、 Remove modules refer to section 6.4.2.

7.2.3.2 Replace or extend modules

The battery modules could be replaced or extended when need.

The SOC of the existing system and the module to be added should be similar before the module adding on the existing system.

Procedure:

- 1、 Normally, for new battery module (manufacture time is less than half a year), the SOC before shipment is 50% (shipping). Charge or discharge the existing system to 45% SOC (tolerance 5%) before replaced or extended.

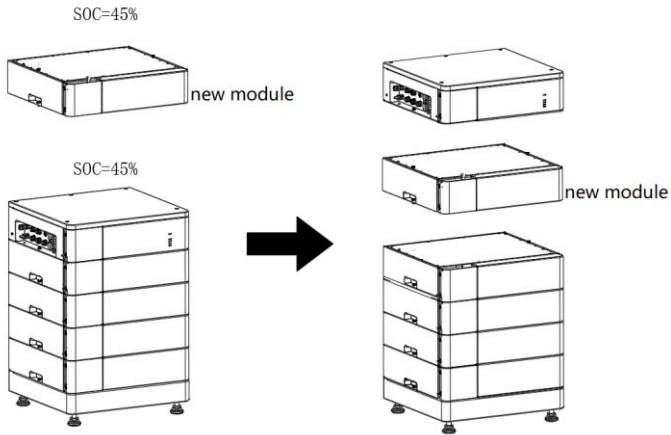

- 2、 For battery modules with a long inventory time, charge the new module to 100% SOC with a charger (charge voltage is 56.16Vdc / 25A, cut off when current less than 2.5A), and charge the existing system to 100% SOC.

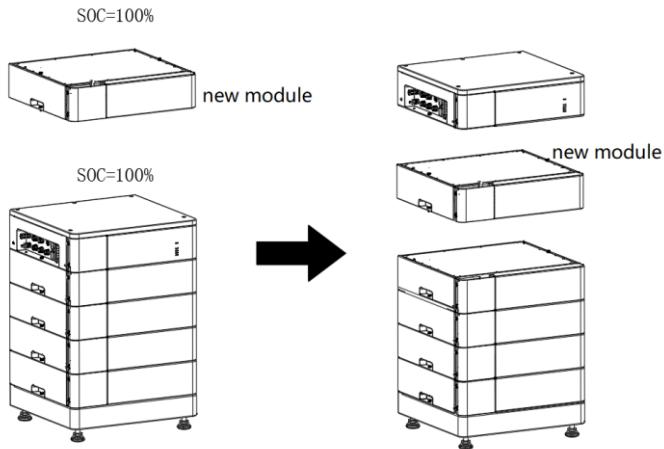

- 3、 Refer to Section 7.2.3.1 to remove GTX3000-BCU or remove modules that need to be replaced.
- 4、 Add the new module on top of other battery modules to the tower.
- 5、 Install battery system refer to section 6.4.2.
- 6、 The battery system is ready to work. The SOC values of the modules will equalize themselves over several cycles.

8 Common Issues and Solutions

The customer is not supposed to replace or change the parts.

If L5 long bright in red, that means an error happens. Contact our local after-sales service within 48 hours when you observe an error.

8.1 Common Issues and Solutions

User can monitor the running status, warnings and alarms information from the App or LCD display of inverter, or battery extend LCD.

1、 Battery cannot turn on, and LED indicator all off

Battery deep discharge, need to charge first. If the external charger power supply voltage is 205V or more, the battery still unable to turn on, please contact Sofar.

2、 The battery can be turned on, but cannot charge or discharge

If the red light is lighting, that means system is abnormal, please check values as following:

a) Temperature: Above 55℃ or under -10℃, the battery could not charge.

Solution: to move battery to the normal operating temperature range between

-10°C and 55°C.

b) Temperature: Above 60°C or under -20°C, the battery could not discharge.

Solution: to move battery to the normal operating temperature range between -20°C and 60°C.

c) Current: If current is greater than 50A, battery protection will turn on.

Solution: If operating current is too large, change the settings on power supply side.

d) High Voltage: If battery voltage is too high (depends on the number of battery modules), battery charge protection will turn on.

Solution: If battery is full charge, please discharge the battery for some time; if charging voltage is too high, change the settings on power supply side.

e) Low Voltage: If the battery voltage is too low (depends on the number of battery modules), battery discharge protection will turn on.

Solution: Charge the battery until the red light turn off.

Excluding the five points above, if the faulty is still cannot be located, turn off battery and contact Sofar.

3. In parallel system, SOC indicator display is different

a) For the first installation, please make a full charge first to balance the capacity

gap;

b) If the lowest SOC LED indicators is only one less than the highest SOC LED indicators, and SOC LED indicator will become same within 10 minutes, it is a normal running status;

4、Other common issues

Issues	Possible Reason	Solution
Cannot close Power Switch	Power Switch fault	Change Power Switch
Cannot break Power Switch		
DC contactor can't be closed	1. BCMU fault 2. 12V DC module fault 3. DC contactor fault 4. Drive cable broken	Break Power Switch first. 1. Change BCMU 2. Change 12V DC module 3. Change DC contactor 4. Change drive cable
DC contactor can't be break		
CAN communication fault	CAN cable broken	Change the CAN cable
Cell voltage or battery temperature collect fail	Power cable between the batteries are loose	Reconnect the cable
Battery system is in normal condition, but no output	BCU DC FUSE break	Change the DC FUSE

Excluding the four points above, if the faulty still exist, please contact Sofar.

8.2 Emergency

Please cut off the power supply and turn off the battery in an emergency.

1) Wet Batteries

If the battery pack is wet or submerged in water, do not let people access it, and then contact Sofar or an authorized dealer for technical support.

2) Fire

NO WATER! Only dry powder fire extinguisher can be used; if possible, move the battery pack to a safe area before it catches fire.

3) Leaking Batteries

If the battery pack leaks electrolyte, avoid contact with the leaking liquid or gas. If someone is exposed to the leaked substance, immediately perform the actions described below.

Inhalation: Evacuate the contaminated area, and seek medical attention.

Contact with eyes: Rinse eyes with flowing water for 15 minutes, and seek medical attention.

Contact with skin: Wash the affected area thoroughly with soap and water, and seek medical attention.

Ingestion: Induce vomiting, and seek medical attention.

4) Damaged Batteries

Damaged batteries are dangerous and must be handled with the utmost care. They are not fit for use and may pose a danger to people or property. If the battery pack seems to be damaged, pack it in its original container, and then return it to Sofar or an authorized dealer.

8.3 Disposal of the Battery System

Disposal of the system must comply with the local applicable disposal regulations for electronic waste and used batteries.

- Do not dispose of the battery system with your household waste.
- Avoid exposing the batteries to high temperatures or direct sunlight.
- Avoid exposing the batteries to high humidity or corrosive atmospheres.



Product Name: Lithium-Ion Storage Battery

Company Name: Shenzhen SOFARSOLAR Co., Ltd.

ADD: 401, Building 4, AnTongDa Industrial Park, District 68, XingDong Community,
XinAn Street, BaoAn District, Shenzhen, Guangdong.P.R. China

Email: service@sofarsolar.com

Tel: 0510-6690 2300

Web: www.sofarsolar.com